













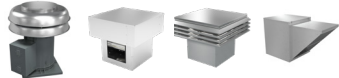
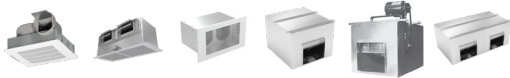

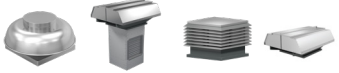

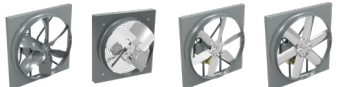
# Product Guide



LOREN COOK COMPANY

Category	Examples	Page	Category	Examples	Page
<b>FEATURES &amp; OPTIONS LEGEND</b>		<b>3</b>	<b>INDUSTRIAL BLOWERS &amp; FANS</b>		<b>17</b>
<b>ROOF &amp; WALL CENTRIFUGAL EXHAUST FANS</b>		<b>8</b>	<b>PLUG &amp; PLENUM FANS</b>		<b>19</b>
<b>ROOF MOUNT CENTRIFUGAL SUPPLY FANS</b>		<b>10</b>	<b>CEILING &amp; WALL CABINET FANS</b>		<b>20</b>
<b>ROOF MOUNT PROPELLER EXHAUST FANS</b>		<b>11</b>	<b>AIR CIRCULATORS</b>		<b>21</b>
<b>ROOF MOUNT PROPELLER SUPPLY FANS</b>		<b>12</b>	<b>LABORATORY EXHAUST</b>		<b>22</b>
<b>WALL MOUNT PROPELLER FANS</b>		<b>14</b>	<b>GRAVITY VENILATORS</b>		<b>24</b>
<b>INLINE MIXED FLOW &amp; CENTRIFUGAL FANS</b>		<b>15</b>	<b>ENERGY RECOVERY &amp; HEATED MAKEUP</b>		<b>25</b>
<b>INLINE AXIAL FANS</b>		<b>16</b>	<b>VARI-FLOW CONTROLS</b>		<b>26</b>





## 24 HOUR EXPRESS

- ▶ HVAC industry's first and most successful custom assembly, next day shipping service.
- ▶ More than 850 items available.
- ▶ Specify CFM, horsepower, voltage, accessories, etc.
- ▶ Units are custom built, test run and shipped the next working day.



## VARI-FLOW®

- ▶ Cook's offering of EC/PM motors and compatible controls.
- ▶ Superior part-load efficiency and demand-based control.
- ▶ Economical controllability for optimal ventilation at the lowest energy consumption.



## SMOKE CONTROL

- ▶ Cook offers the industry's broadest product selection.
- ▶ Cook pioneered the development of UL's "Power Ventilator for Smoke Control Systems" in 1990.



## UL RESTAURANT EXHAUST

- ▶ UL Listed Power Roof Ventilators for Restaurant Exhaust.
- ▶ Tested to handle grease-laden air at elevated temperatures and during grease flare-up.
- ▶ Designed to meet the National Fire Protection Association (NFPA) Standard 96 installation guidelines.



## SEISMIC

- ▶ Seismic rated fans have been 3<sup>rd</sup> party shake table tested.
- ▶ Tested in accordance to ICC-ES AC156 with an acceleration ranging to 2.5G's (SDS = 2.50).
- ▶ All tests accepted by the California Office of Statewide Health Care Planning and Development (OSHPD), now known as California Department of Health Care Access and Information (HCAI), as part of the pre-approval program.



## MIAMI-DADE

- ▶ Product designed for high wind velocity weather.
- ▶ Tested and met Miami-Dade County's TAS-201, TAS-202, and TAS-203 criteria.
- ▶ Florida Building Commission approved.



## AMCA

- ▶ Cook products bearing AMCA Certified Ratings label.
- ▶ These products have been tested in Cook's own accredited laboratories and checked by AMCA international.
- ▶ This third-party certification ensures performance as promised.

ICON MAY NOT APPLY TO ALL MODELS. PLEASE SEE PRODUCT CATALOG FOR AVAILABILITY.



# COOK SELECT

## Efficient and Powerful Fan Selection Tool

- Browser-based. No downloads!
- Always up-to-date!
- Simple, intuitive user interface
- Contextual linking to lorencook.com
- Stable and reliable
- Visual cues aid selection
- Flexible viewing structure
- As fast as your internet connection will allow!

The screenshot shows the COOK SELECT web application interface. It includes a top navigation bar with 'AMCA' and 'Tools' options. A left sidebar contains filter categories: PRODUCT FAMILY, DRIVE TYPE, AIRFLOW TYPE, and INSTALLATION LOCATION. The main area displays a grid of product thumbnails with details like 'ACE', 'ACRU', and 'ACSC'. A bottom section shows a data table with columns for Drive Type, Speed Control, and various performance metrics.

- Easy-to-read summary view form
- Live, synchronized Information panel updates with selection grid navigation
- Customizable grid columns
- Data filters and sort capability
- Collapsible/expandable information sections



## Key Features

### Selection Options For Everyone

Thumbnail images with key at-a-glance information, powerful filters, and product search field allow efficient product selection, whether seasoned system designer or relative novice.

This screenshot highlights key features of the COOK SELECT interface. Red circles and arrows point to the 'Product Search Field' at the top, 'Powerful Filters' in the sidebar, and 'Product Thumbnails' in the main grid. The interface shows a dashboard with navigation steps: 1 Model Selection, 2 Design Conditions, 3 Unit Selection.

### Customizable Selection Grid

The screenshot shows a customizable data table with columns for various fan specifications. The table is titled 'COOK SELECT Dashboard' and includes a 'Show Unselected' button. The table has 12 columns: Unit Name, Drive Type, Speed Control, Vari-Flow Controls, SimpliDrive, Airflow (CFM), Static Pressure (INWC), Nominal Impeller Size (IN), Drive Loss, Wheel Width, Brake HP, Motor HP, Hz, and F.

Unit Name	Drive Type	Speed Control	Vari-Flow Controls	SimpliDrive	Airflow (CFM)	Static Pressure (INWC)	Nominal Impeller Size (IN)	Drive Loss	Wheel Width	Brake HP	Motor HP	Hz	F
101 ACED	Direct Drive	EC			1,900	0.250	10.0	—	100%	0.559	0.625	—	
120 ACEB	Belt Drive	None			1,500	0.250	12.0	16%	100%	0.266	0.333	—	
120 ACEB	Belt Drive	VFD			1,500	0.250	12.0	16%	100%	0.266	0.500	49	
120 ACEB OR92	Belt Drive	None			1,500	0.250	12.0	15%	100%	0.359	0.500	—	
120 ACEB OR92	Belt Drive	VFD			1,500	0.250	12.0	15%	100%	0.359	0.500	54	

Drag-and-drop column arrangement puts information where you want it. Data filters and sort capability allow you to quickly narrow fan selections. Sort by ascending or descending order or search for the exact data point you are looking for!



Contact your Cook Representative for more information or to schedule a training session!



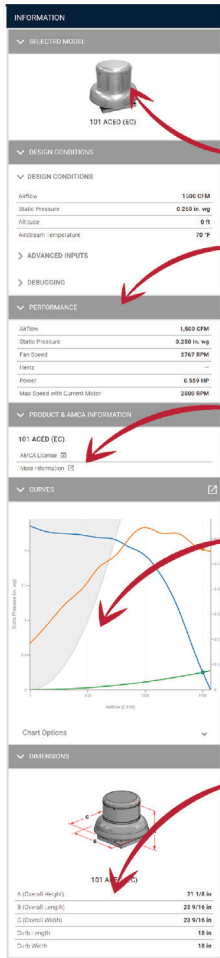

While in the unit selection step, the information panel on the right provides live, synchronized, easy-to-read summary of key fan information

### Thumbnail Image and Model Confirmation

Useful when evaluating multiple models and sizes.

### Product Performance Summary

Confirms operating point and summarizes key data including fan speed, VFD Hz (if appropriate), brake horsepower, and max speed with current motor!

### AMCA Label and lorencook.com Product Page

Convenient links to Information when you need it!

### Customizable Fan Curve

Configure view with a few clicks. Clicking on the 'flyout' icon on the upper right reveals a synchronized printable product summary page with interactive configurable fan curve.

### Overall Product Dimensions

Key dimensions allow you to quickly evaluate physical size against available space!

## Scheduling Fans is Quick and Easy

Quickly order fields to your liking, add notes and export to .xlsx file format!

Export Schedule

Mark Name	Use Name	Notes	Manufacturer	Drive Type	Speed Control	Airflow (CFM)	Static Pressure (in. wg)	Nominal Impeller Size (in)	Wheel Width (%)
Mark	120 TLED	1-3, 4, 5, 6	COOK	Direct Drive	EC	1,500	0.250	12.0	100%
Mark.2	120 ACEB	1-3, 5	COOK	Ball Drive	None	1,500	0.250	12.0	100%

## Notes Tool is Simple Yet Powerful

Adding notes is a simple process:

- Select from provided general notes
- Create custom notes
- Add these notes to your job
- Assign notes to specific fans

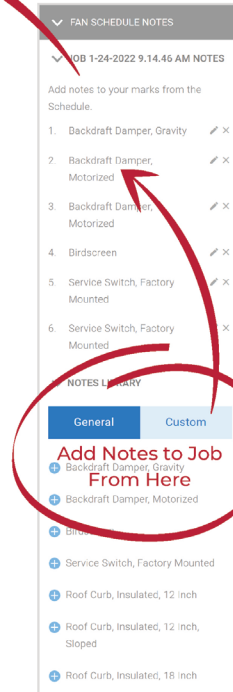

CookSelect provides DOE and CEC required performance data to allow you to make the best application decisions



# MAC Mobile Air Cleaner

Air filtration exactly where you need it!

Cook's Mobile Air Cleaner can be moved into service at a moment's notice.



## Standard Features:

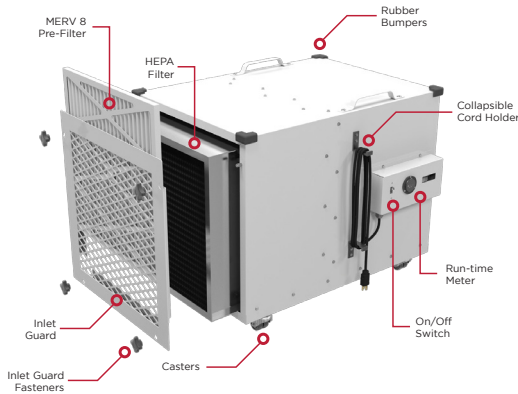

- MERV 8 pre-filter - (24x24x1")
- 99.97% efficient HEPA filter - (24x24x12")
- Airflow range: 601 - 2000 CFM
- Lorenized powder coat finish
- Swivel casters with locking brakes
- 9 foot, 115 volt power cord
- Variable speed control
- Illuminated on/off switch
- Run-time meter
- Tool-less filter changes



Contact your **Cook Representative** or visit [lorencook.com](http://lorencook.com) for more information!

# MAC UV Mobile Air Cleaner

HEPA Filtration and UVGI in one package!

The MAC UV captures airborne pathogens and inactivates them with a UV-C light bath.



## Standard Features:

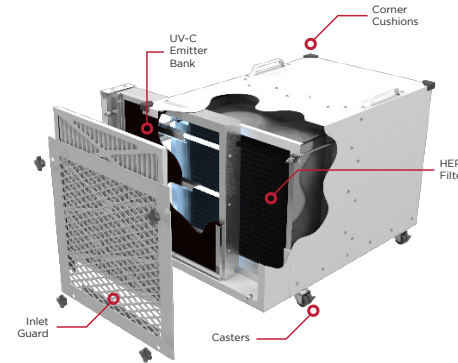

- 270 watts of constant UV-C germicidal irradiation
- HEPA - 99.97% efficient filtration
- Airflow range: 601-1900 CFM
- Lorenized powder coat finish
- 4" swivel casters with locking brakes
- 9 foot, 115V power cord
- Variable speed control
- Illuminated on/off switch
- Run-time meter
- Corner cushions



Contact your **Cook Representative** or visit [lorencook.com](http://lorencook.com) for more information!





# JetStream

## Ductless Bi-directional Jet Fan

Ventilate your parking facility, quietly and efficiently!

Ductwork in garage ventilation has its drawbacks. Low headroom and closely spaced beams often make ductwork impractical. Strategically placed JetStream fans push or pull the air through the entire structure, sweeping it free of CO and other noxious gases.

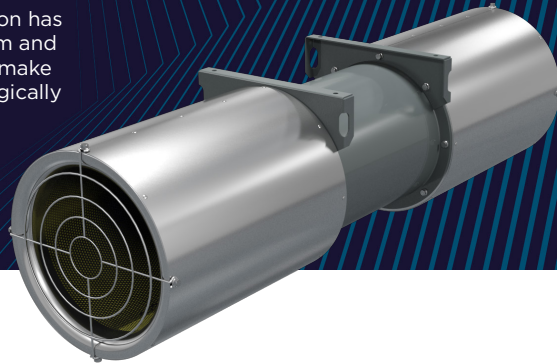

### Standard Features:

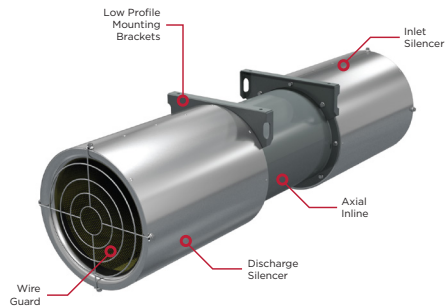

- At the heart of the JetStream fan is a tube axial fan with a high efficiency cast aluminum propeller
- Direct drive for efficiency and reduced maintenance
- Compact design
- Flexible performance
- Low profile mounting brackets
- Inlet and outlet silencers for quiet operation
- UL Listed for smoke exhaust in emergency situation
- Available in three compact sizes with a wide range of performances



Contact your **Cook Representative** or visit [lorencook.com](http://lorencook.com) for more information!

# VFD

## Variable Frequency Drives Streamlined!

Fan, Motor and VFD  
from one source!



### Standard Features:



- Precision motor control for demand-based ventilation and energy savings
- Robust and reliable
- Soft start and stop increases life of fan components
- Simple installation
- Easy programming
- Direct interface with Cook complete line of Vari-Flow controls
- Modbus compatible
- BACnet compatibility on HVAC drives



Contact your **Cook Representative** or visit [lorencook.com](http://lorencook.com) for more information!



### ACE

Size Range:  
 Belt - 60 to 540  
 Direct - 70 to 300

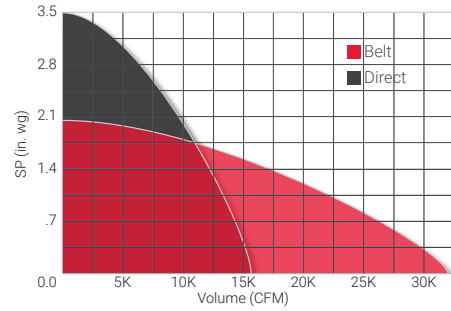

### ACW

Size Range:  
 Belt - 100 to 245  
 Direct - 70 to 245

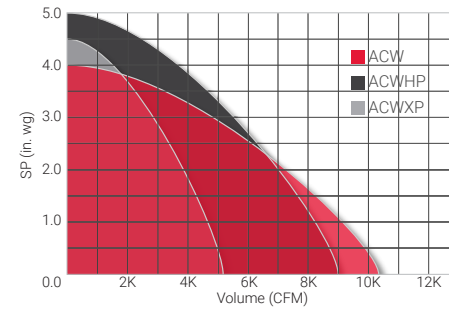

### ACRU

Size Range:  
 Belt - 100 to 490  
 Direct - 70 to 300

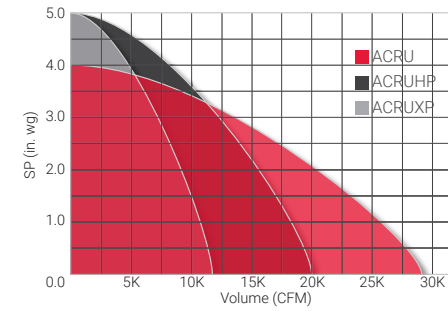

### ACSC

Size Range:  
 Belt - 100 to 490

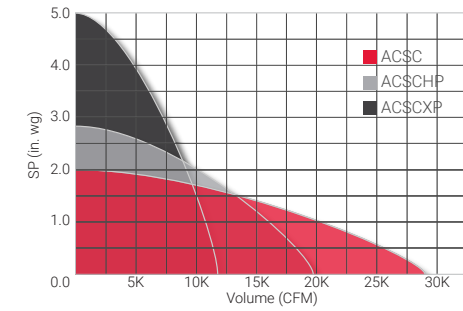

### VCR

Size Range:  
 Belt - 100 to 490  
 Direct - 101 to 300

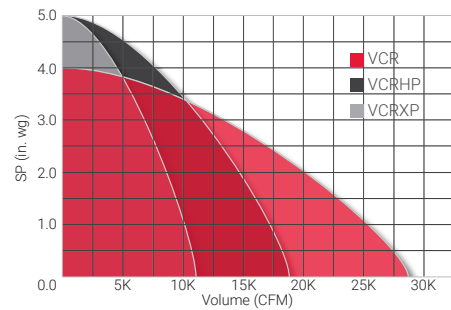

### SRSH

Size Range:  
 Belt - 60 to 270  
 Direct - 60 to 180

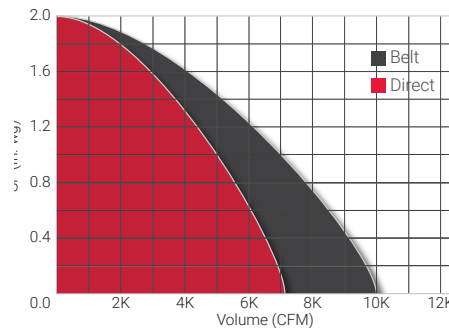

### FCE

Size Range:  
 Belt - 120 to 402  
 Direct - 120 to 180

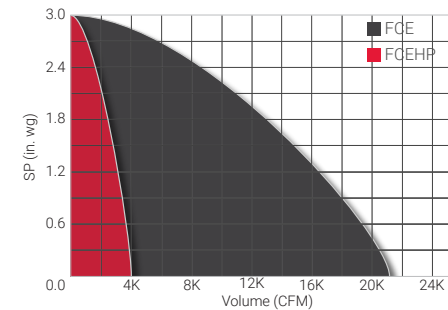

### FCRU

Size Range:  
 Belt - 120 to 402  
 Direct - 120 to 180

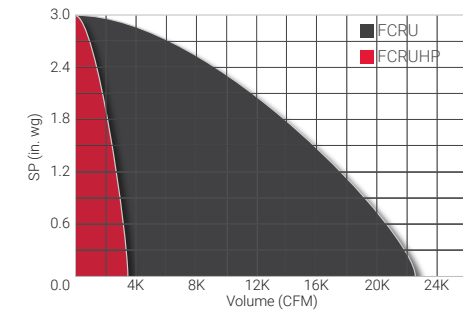



## LP

Size Range:  
Belt - 100 to 540  
Direct - 100 to 165

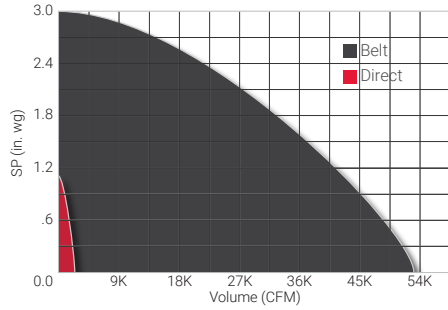
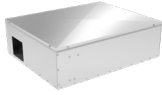

## HLC

Size Range:  
Belt - 100 to 540  
Direct - 70 to 180

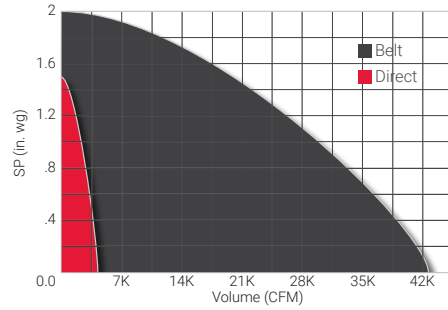
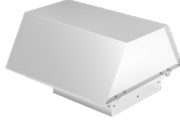

## TLC

Size Range:  
Belt - 100 to 540  
Direct - 70 to 180

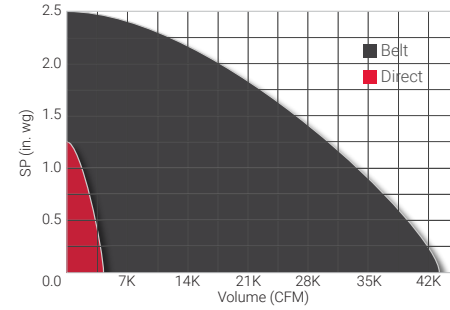

## Notes:

## QMXE

Size Range:  
QMXE - 90 to 300  
QMXHPE - 90 to 300  
QMXXPE - 150 to 300

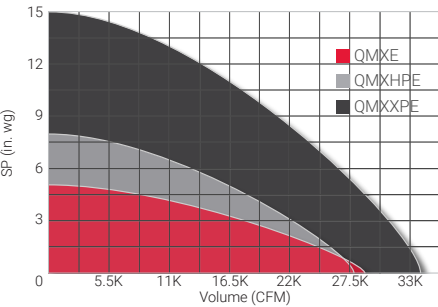

## QMXU

Size Range:  
QMXU - 90 to 600  
QMXHPU - 90 to 600  
QMXXPU - 150 to 600

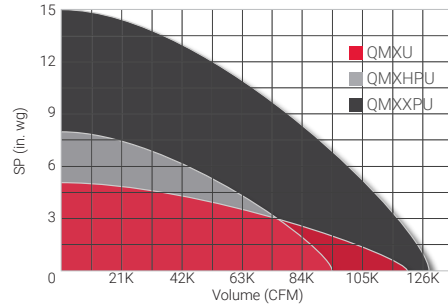

## TCNU

Size Range:  
60 to 490

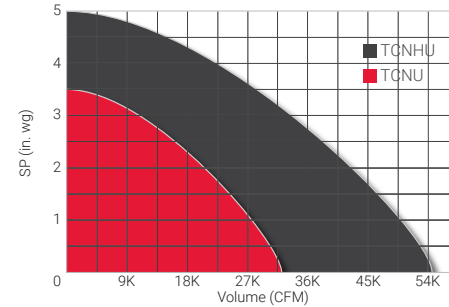

### QMXS

Size Range:

- QMXS - 90 to 300
- QMXHPS - 90 to 300
- QMXXPS - 150 to 300

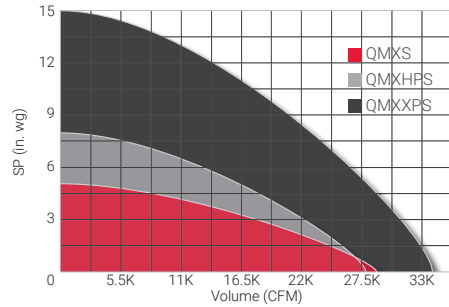

### ASP

Size Range:  
90 - 200

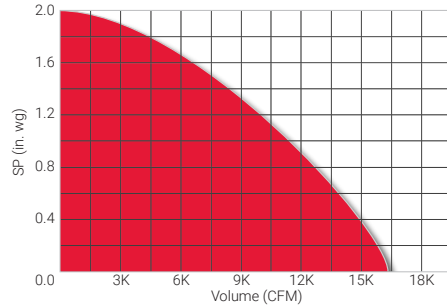

### ASP-T

Size Range:  
90 - 200

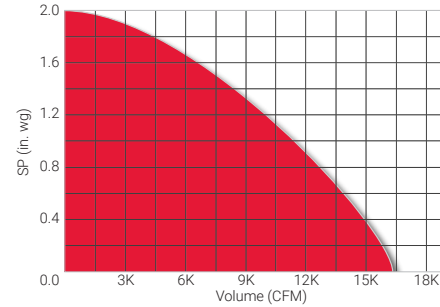

### KSP

Size Range:

- KSPD - 94 to 127
- KSPB - 90 to 200

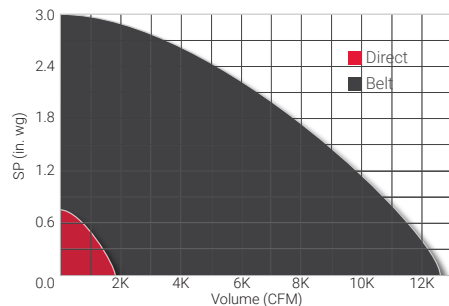
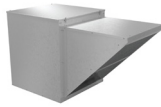

### CFS

Size Range:  
120 to 365

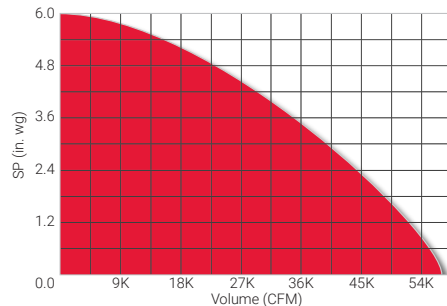
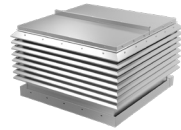

# CookTools

A collection of tools for mechanical designers



## 6 Apps in 1!

### Fan Law Calculator

- Quickly determine new operating point from known quantities

### Sound Calculator

- Compute LwA, dBA, sones and NC from octave band data

### Duct Designer

- Quickly calculate rectangular and round duct sizes

### Area Calculator

- Compute section properties of round and rectangular shapes

### Unit Conversion

- Choose from airflow, velocity, distance, pressure, weight, area, temperature, power or volume

### Psychrometric Calculator

- Input altitude, temperature and humidity

## The smartphone is the new toolbox.

Make sure you have the latest tools in yours!



Apple



Android

Contact your **Cook Representative** or visit **lorencook.com** for more information!



## Low Silhouette

Size Range:  
20 to 60

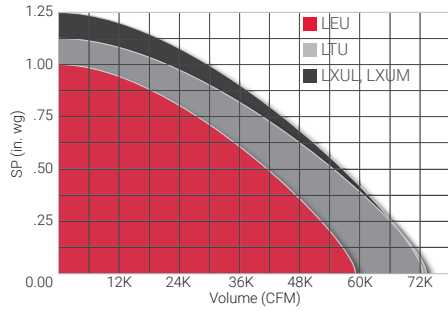

## Low Silhouette (Motor Outside)

Size Range:  
20 to 60

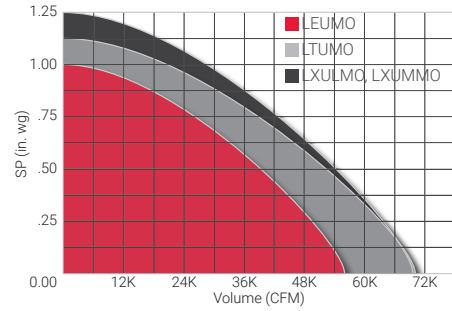

## AU

Size Range:  
Belt - 24 to 48  
Direct - 20 to 48

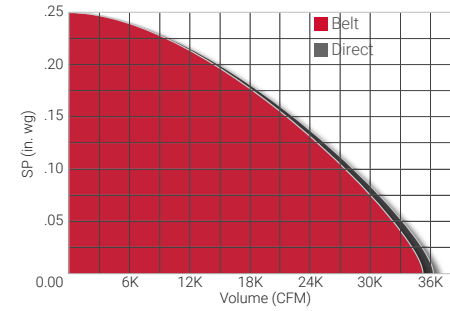

## TU

Size Range:  
Belt - 24 to 72  
Direct - 20 to 60

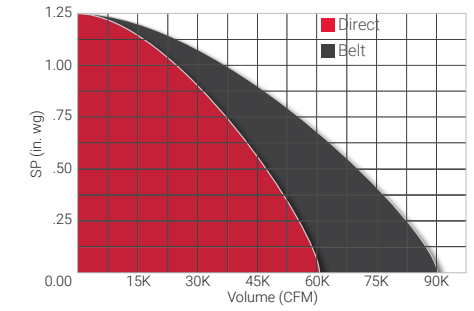

## EU

Size Range:  
Belt - 24 to 72  
Direct - 20 to 48

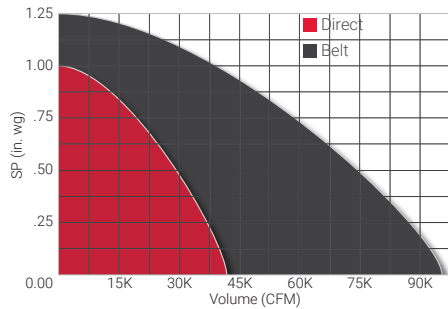

## AI

Size Range:  
Level 1 - 31 to 160  
Level 2 - 41 to 160

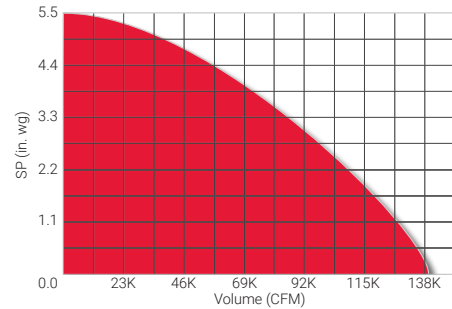

## NEW LOOK

More Ways to Connect!

**LORENCOOK.COM**

AMERICAN MADE QUALITY SINCE 1941

AMERICAN MADE

SELECT YOUR APPLICATION

General Ventilation, Kitchen Ventilation, Smoke Control, Industrial, Laboratory Ventilation, etc.

YouTube: Fan Performance 101 Ducted Fan Performance Part 2

COOK Experts in Air Filtration Since 1941

8:51



### HEE

Size Range:  
24 to 60

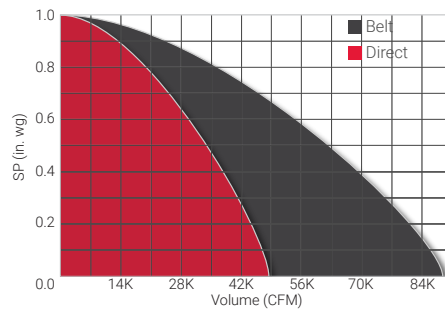

### HXE Belt Drive

Size Range:  
20 to 60

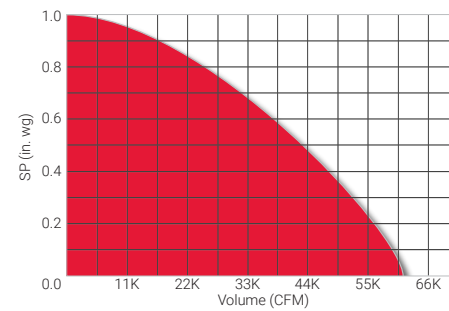

### ECONOMIZER

Size Range:  
MRSE-D - 24 to 54

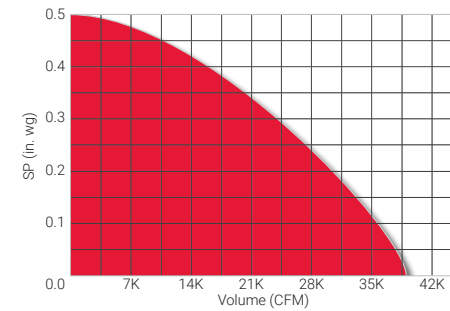

### Notes:

### ETE

Size Range:  
24 to 60

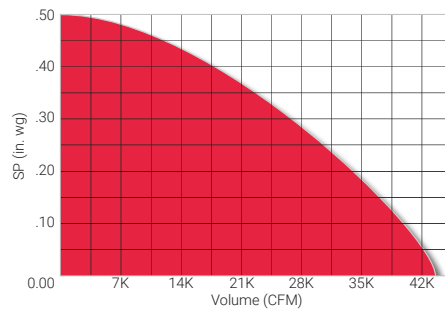

### REBE

Size Range:  
12 to 24

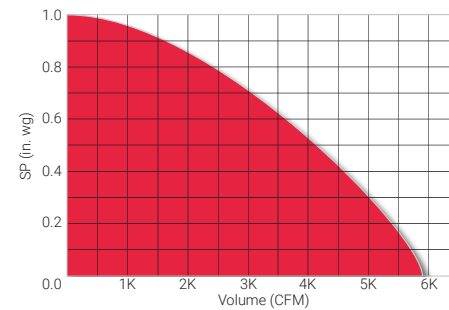
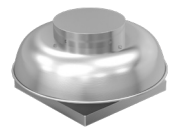

### AQ

Size Range:  
AQD - 12 to 48  
AQB - 24 to 48

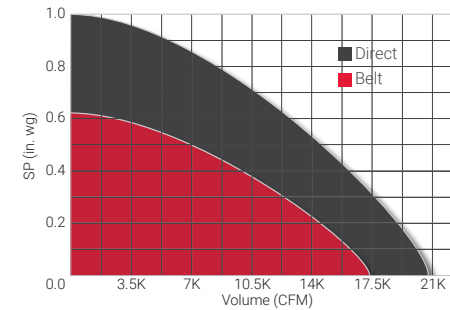
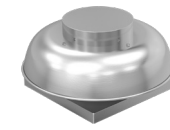

## HES

Size Range:  
24 to 54

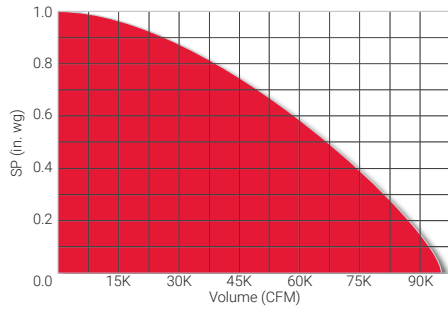

## HEF

Size Range:  
24 to 60

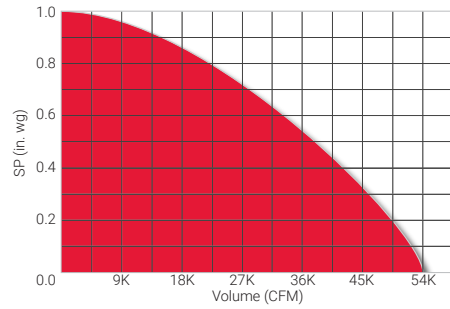

## HX Belt Drive

Size Range:  
20 to 60

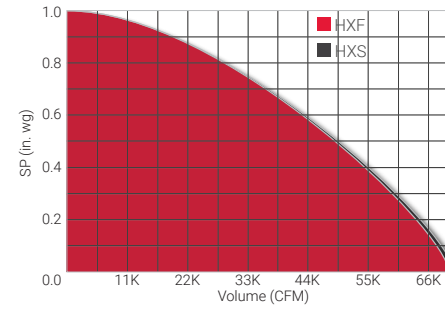

## REBS

Size Range:  
12 to 24

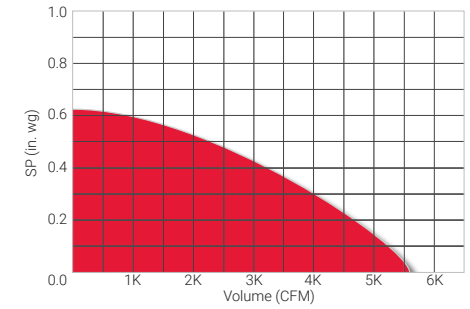
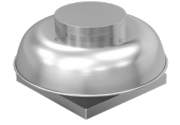

## ECONOMIZER

Size Range:  
MRS-D - 24 to 54

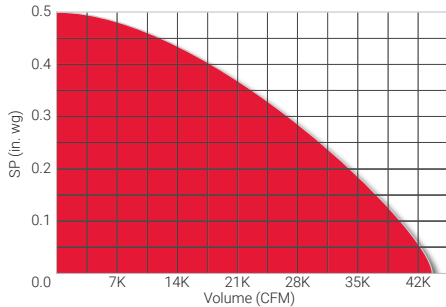

**COATINGS** BROCHURE

***Did you know?***

Cook has a wide variety  
of coating options!

View our Coating  
Brochure for details!





## X Series

Size Range:  
Standard - 8 to 24  
HD - 12 to 24

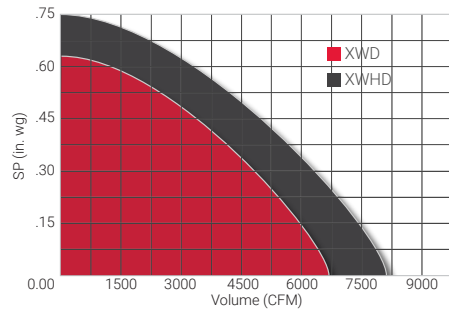

## X.Stream

Size Range:  
20 to 60

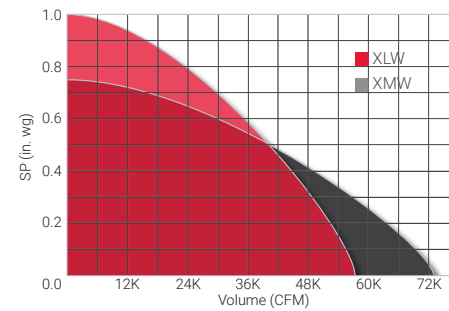
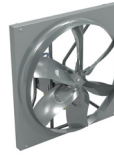

## CookSelect Mobile

**Browser-Based Fan Selection from Your Smartphone Anywhere You Have Access to the Internet!**

### Four Easy Steps!

- » Select by category, application or model
- » Input CFM, SP and quickly view valid selections
- » Click on any selection
- » Performance summary and model info at your fingertips

### Want to Share?

- » Tag fan for future reference
- » Save selection as a PDF
- » Attach to email
- » Send!

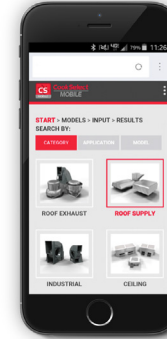

No need to wait until you get back to the office! PDF is formatted in the familiar Cook submittal style your customers are used to!

CookSelect Mobile is built into the CookTools menu.

**Download CookTools today!**

## COOK SELECT

**Efficient and Powerful Fan Selection Tool on Your Desktop!**

### Scheduling Fans is Quick and Easy!

- » Browser-based. No downloads required!
- » Always up-to-date!
- » Simple, intuitive user interface
- » Powerful filters to aid in selection
- » Customizable selection grid and fan curves
- » Convenient links to [lorencook.com](http://lorencook.com) for product information
- » Simple, yet powerful notes tool to build your fan schedule
- » Schedule exports to .xlsx file format

### Start your fan schedule now!

[cookselect.lorencook.com](http://cookselect.lorencook.com)

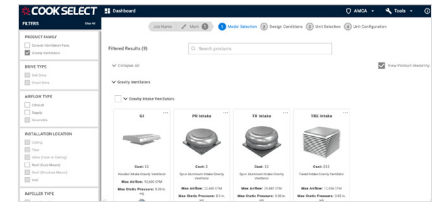

## A Series

Size Range:  
Belt - 12 to 48  
Direct - 24 to 48

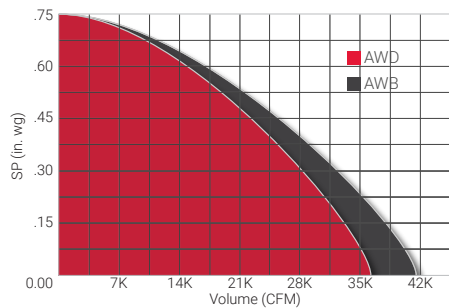

## E Series

Size Range:  
Belt - 24 to 72  
Direct - 20 to 54

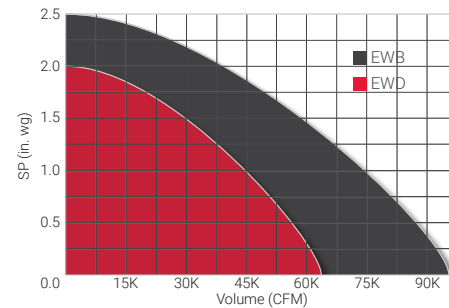
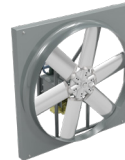

## Engineering Cookbook

**A convenient reference for HVAC designers**



- » Fan Basics
- » System Design
- » Heating and Refrigeration
- » Duct Design
- » Formulas and Conversions
- » Motors and Drives



LorenCook.com

CookTools Flyer | May 2022



## QMX

Size Range:  
 QMX - 90 to 600  
 QMXHP - 90 to 600  
 QMXXP - 150 to 600

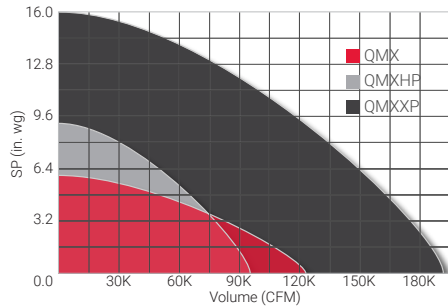

## TMX

Size Range:  
 ARR 9 - 90 to 330  
 ARR 4 - 90 to 245

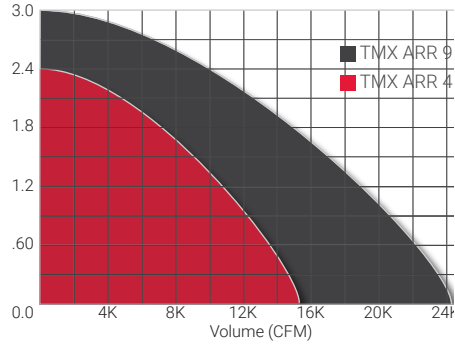

## SQN

Size Range:  
 SQN - 60 to 402  
 SQNHP - 135 to 402  
 SQND - 70 to 365

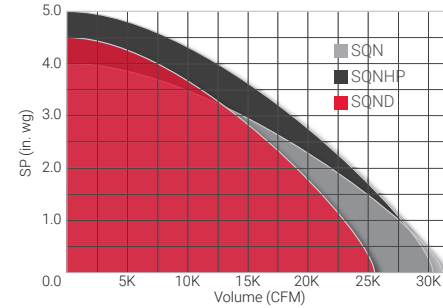
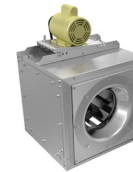

## SQI

Size Range:  
 SQI - 90 to 402  
 SQIHP - 135 to 402  
 SQID - 70 to 165

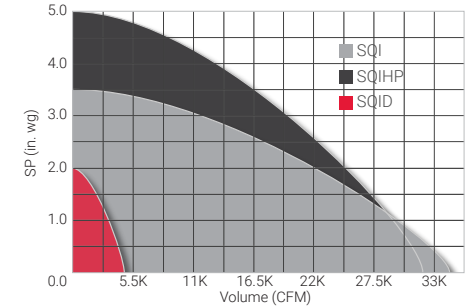

## TCN

Size Range:  
 TCN - 60 to 490  
 TCND - 60 to 165

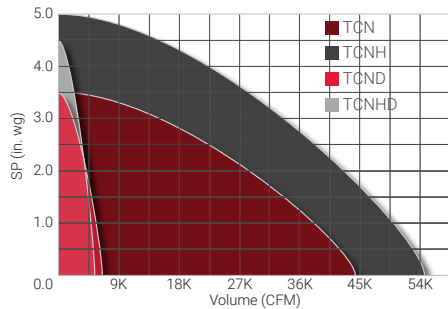

## CV

Size Range:  
 Belt - 10 to 36  
 Direct - 8 to 20

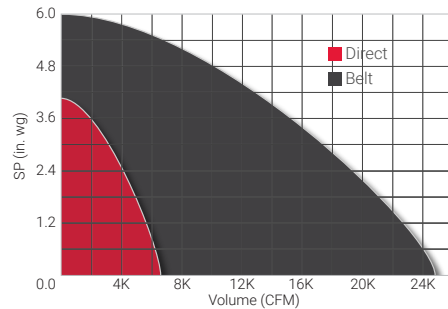

## CVS

Size Range:  
 Belt - 10 to 36

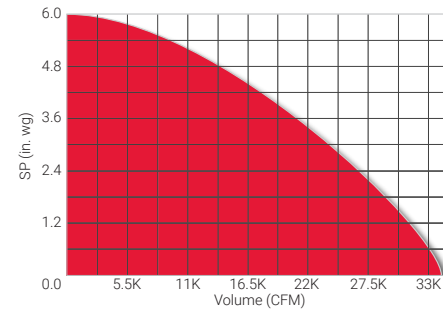

## Notes:



## AI

Size Range:  
Level 1 - 31 to 160  
Level 2 - 41 to 160

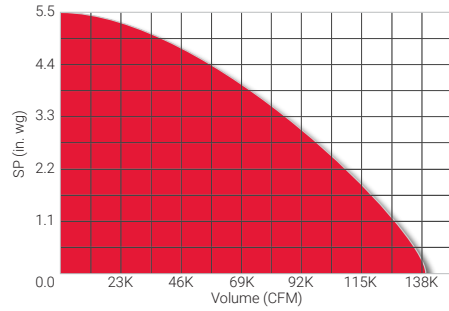

## Tube Axial

Size Range:  
A Series - 16 to 48  
Triton - 20 to 72  
E Series - 20 to 60

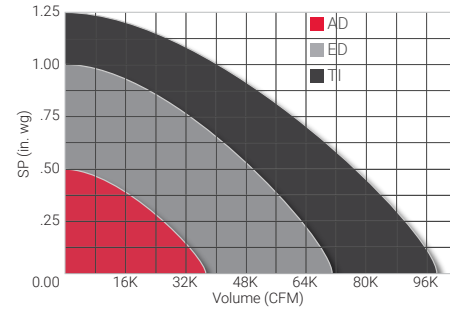

## Fixed Pitch Vane Axial

Size Range:  
VAD - 18 to 60  
VAB - 12 to 60  
VAHB - 12 to 60

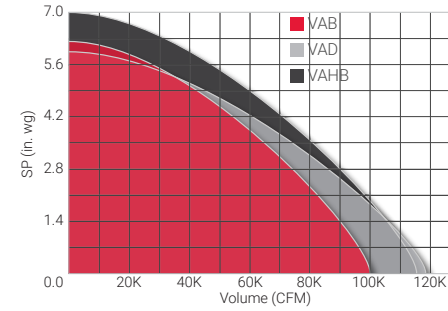

## Adjustable Vane Axial

Size Range:  
AVAD - 35 to 79  
AVAB - 35 to 79

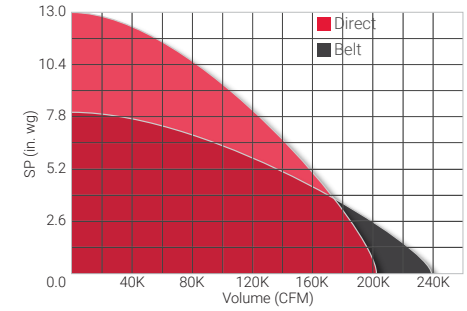

## Fixed Tube Axial

Size Range:  
AF-C - 12 to 60

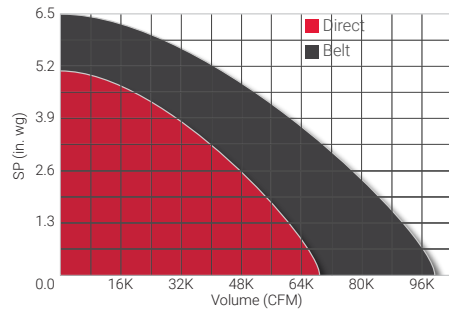

## Fixed Tube Axial

Size Range:  
AF-S - 12 to 36  
AF-H - 12 to 36

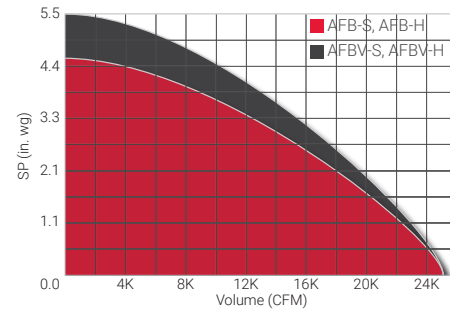

## XIB

Size Range:  
24 to 60

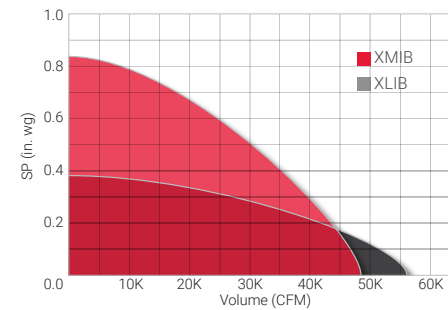

## JetStream

Size Range:  
31 to 41

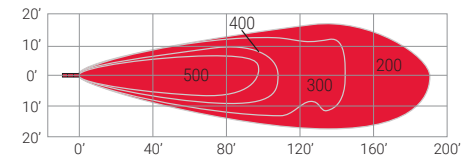

## CPS

Size Range:  
CPS - 60 to 490  
CPS-A - 120 to 490

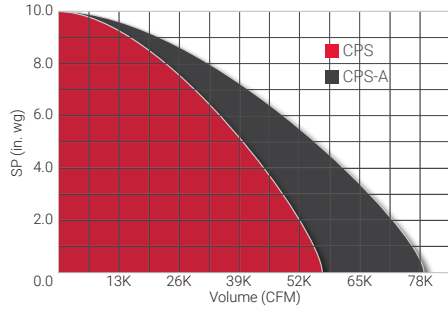

## CPA

Size Range:  
CPA - 60 to 490  
CPA-A - 120 to 490

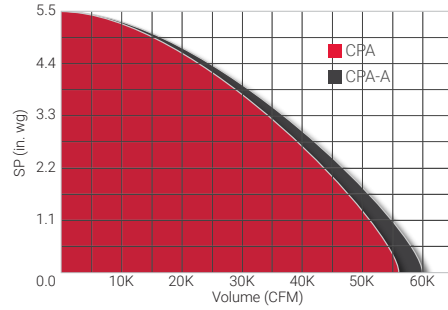
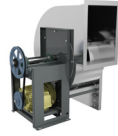

## CPV

Size Range:  
60 to 490

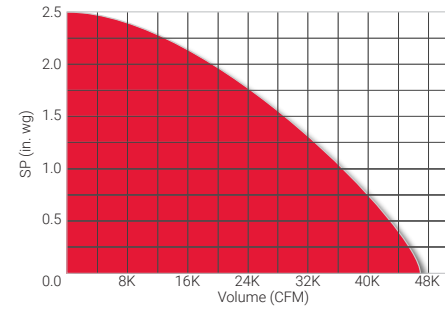

## CPF B

Size Range:  
100 to 300

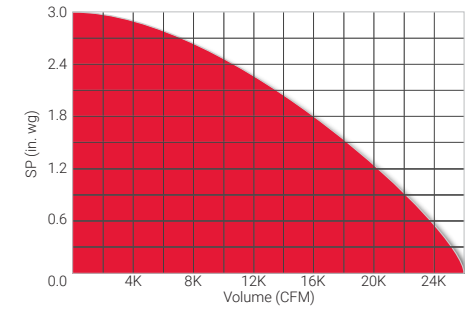

## CPFD

Size Range:  
6 to 12

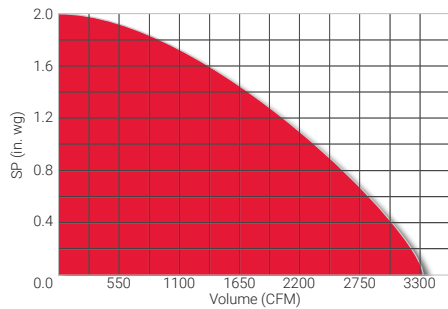

## FCP

Size Range:  
120 to 365

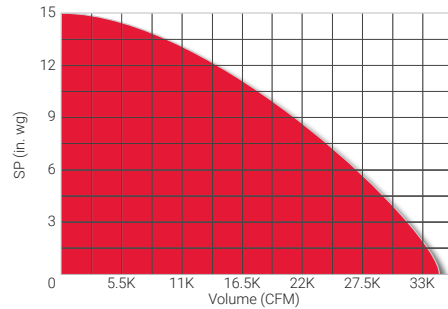

## CA/CF SWSI

Size Range:  
120 to 730

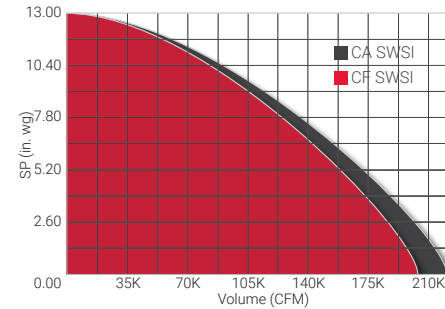

## CA-4/CF-4 SWSI

Size Range:  
120 to 730

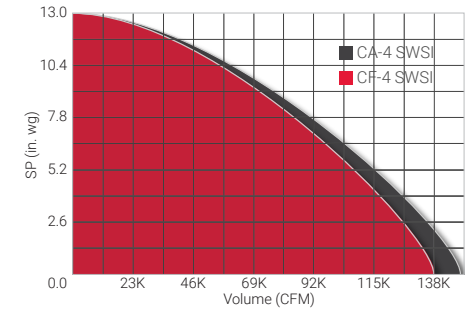



## CA-DWDI

Size Range:  
CA DWDI - 120 to 730

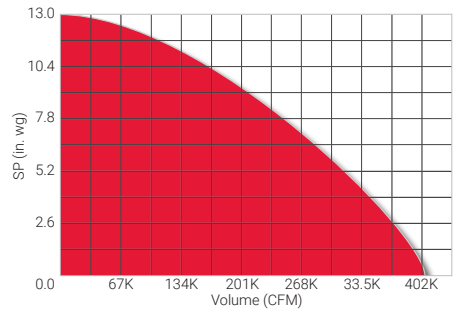

## CA-4 DWDI

Size Range:  
120 to 730

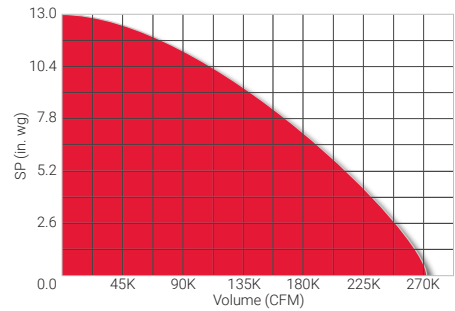

## CAF-DW

Size Range:  
120 to 730

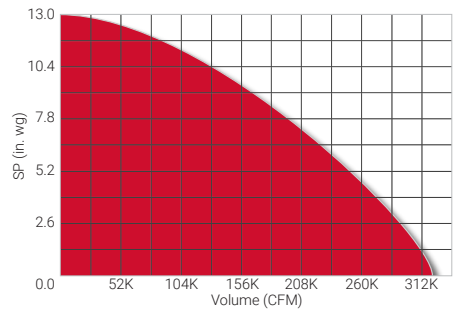

## Material Air Handlers

Size Range:  
70 to 290

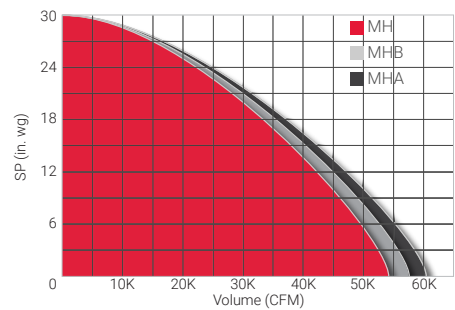

# CA/CF

## Direct Drive Industrial Blowers

Direct drive blowers provide reliability and reduced maintenance



Arrangement 4

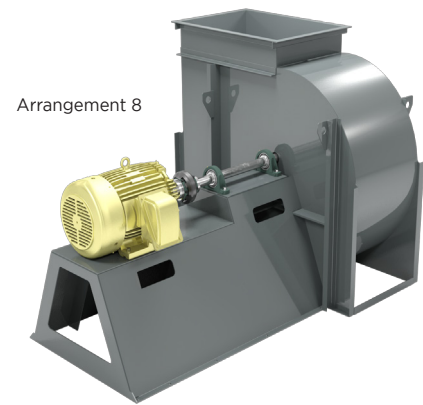

Arrangement 8

## Configuration Options:

- Class 1, 2, & 3
- Up to size 730
- 7 Discharge positions
- Airfoil (CA) or backward inclined (CF) wheels
- Units available up to 200 HP



Contact your **Cook Representative** or visit [lorencook.com](http://lorencook.com) for more information!



## More Direct Drive Options

Have specialized direct drive applications?

Cook designs, fabricates, welds, assembles, and delivers industrial blowers for your specialized requirements.

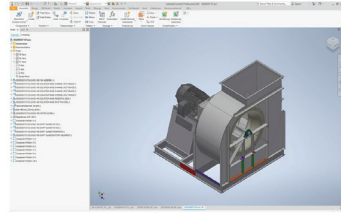

Utilizing the latest technology Cook designs and verifies the blowers and construction in a virtual environment.



Tested and ready to ship direct to you for your specialized projects.

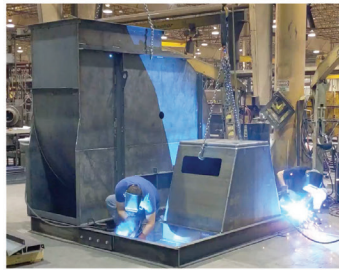

Fabricated, welded and assembled in the USA.



## Plenum Fan

Size Range:  
120 to 730

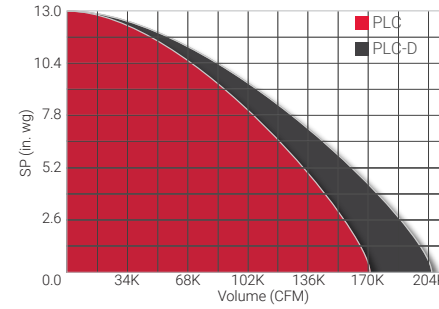

## Plug Fan

Size Range:  
120 to 445

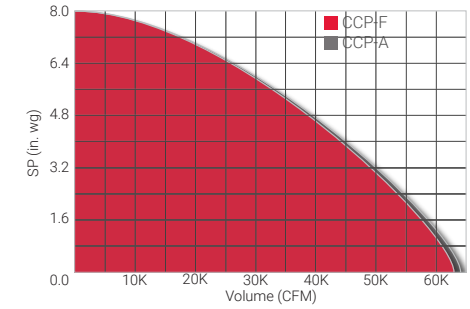

## Modular Plenum Array

Size Range:  
100 to 402

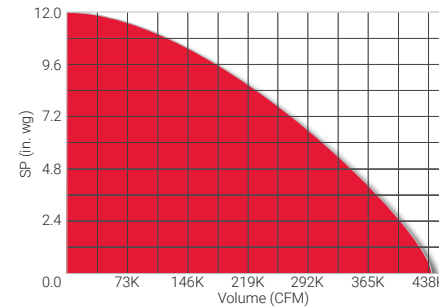
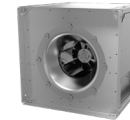

## MPA

STACKING CHART						SIZE RANGE
1x1	1x2	1x3	-	-	All	
-	2x2	2x3	2x4	2x5	100 - 365	
-	-	3x3	3x4	3x5	100 - 245	
-	-	-	4x4	4x5	100 - 165	

For Reference - 3x3

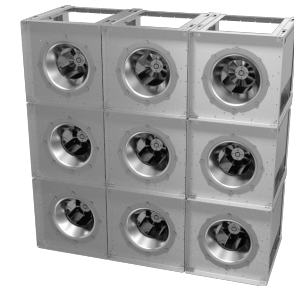

### Gemini

Size Range:  
GC - 126 to 740  
GN - 126 to 740

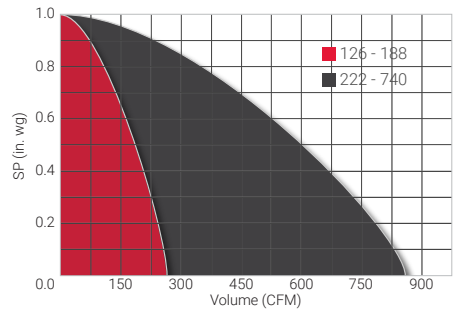

### Gemini

Size Range:  
GC - 822 to 2000  
GN - 822 to 2000

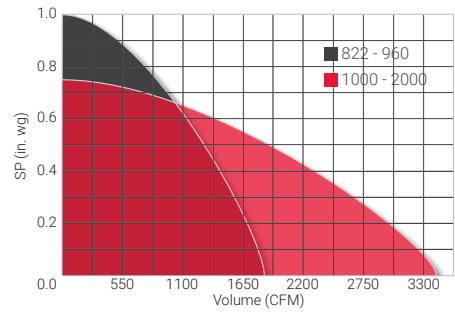

### DB & DBX

Size Range:  
8 to 18

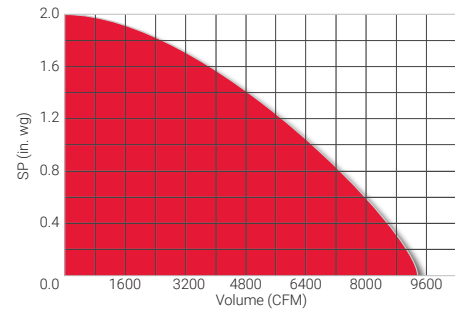

### SDB

Size Range:  
100 to 245

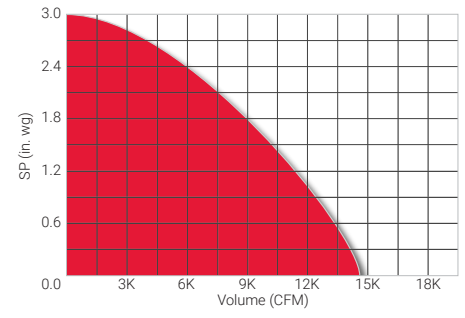

### TDB

Size Range:  
8 to 18

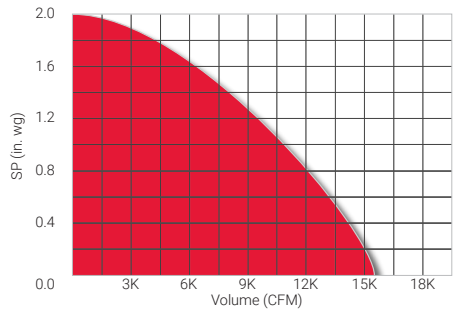

### CBF

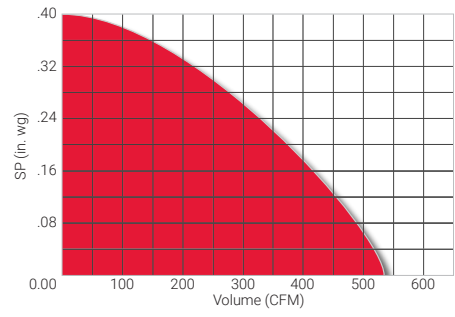

**GCVF 100**  
Named Energy Star Most Efficient Ventilating Fans for the fifth consecutive year

**Most Efficient 2023**  
[www.energystar.gov](http://www.energystar.gov)

**Most Efficient 2022**  
[www.energystar.gov](http://www.energystar.gov)

**Most Efficient 2021**  
[www.energystar.gov](http://www.energystar.gov)

**Most Efficient 2020**  
[www.energystar.gov](http://www.energystar.gov)

**Most Efficient 2019**  
[www.energystar.gov](http://www.energystar.gov)

## Air Circulator Heads

Size Range:  
CAC-ACH - 24" & 30"  
CAC-ACHO - 24" & 30"

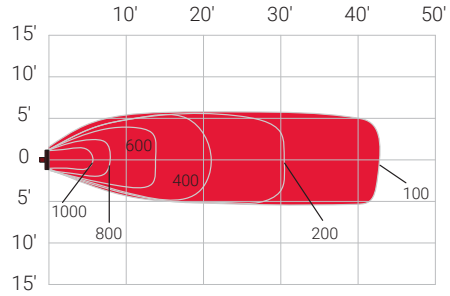

## Air Circulator (Washdown)

Size Range:  
CAC-IHPWD 24" to 30"

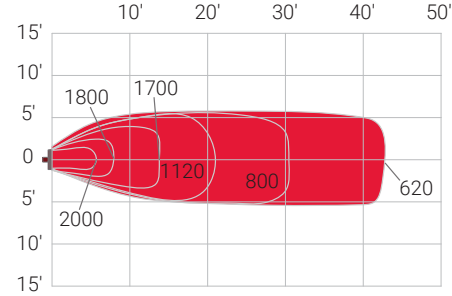

## Ceiling Mount

Size Range:  
CAC-UTE 18"

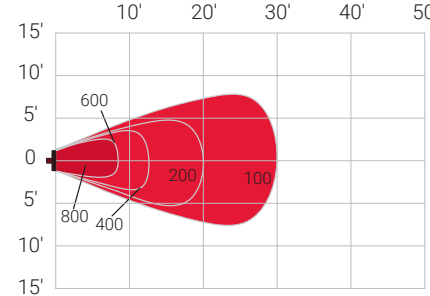

## Notes:

## Suspension Blower

Size Range:  
CAC-SBD - 36" & 42"

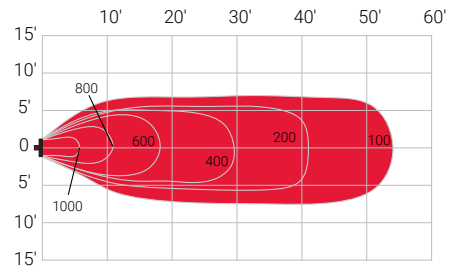

## Portable Blowers

Size Range:  
CAC-PBB - 36 to 48"

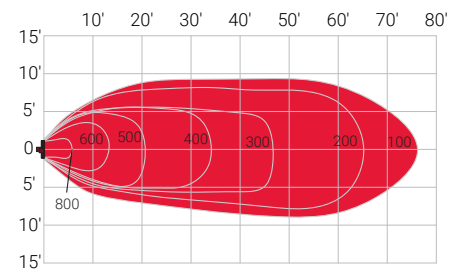
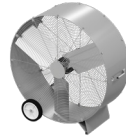

## Mini-Blower Head

Size Range:  
CAC-MBDY 24" & 30"

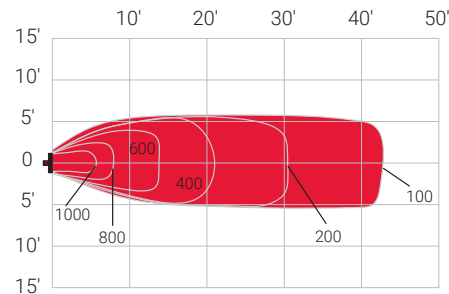



## CPSLE

Size Range:  
60 to 245

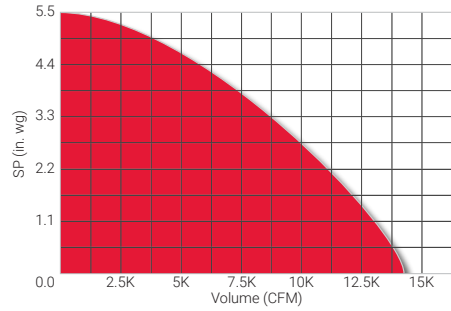

## TCNHBLE

Size Range:  
100 to 490

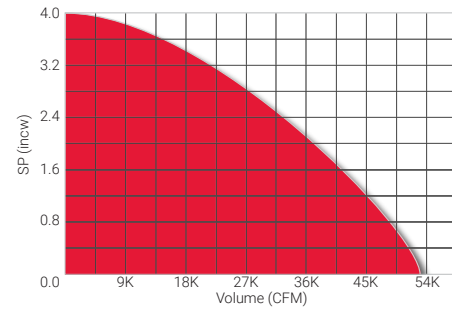

## QMXLE

Size Range:  
QMX - 90 to 490  
QMXD - 150 to 490

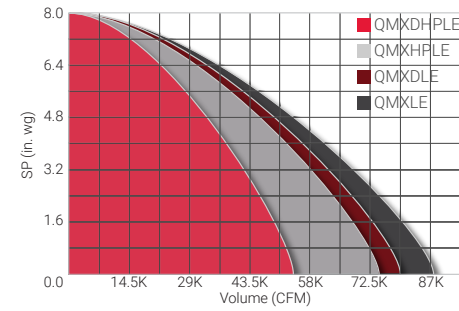

## Fans with Mixing Boxes

- ▶ Convenient method of connecting parallel laboratory exhaust fans.
- ▶ Allows for redundancy and rotation of idle fans.

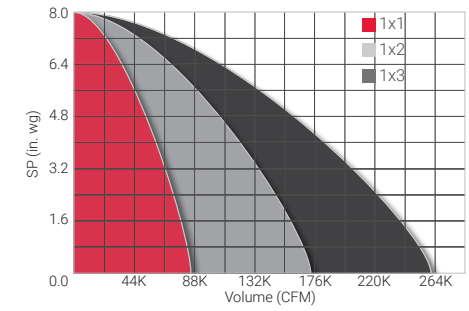

## CAVP

Size Range:  
120 to 730

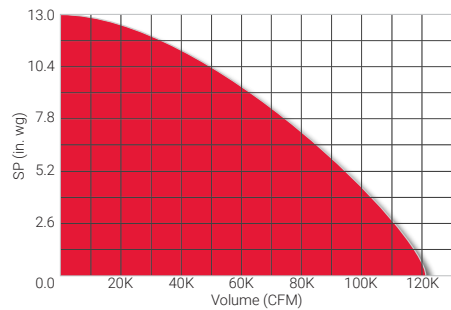
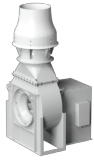

## QMXVP

Size Range:  
QMX - 90 to 600  
QMXD - 150 to 600

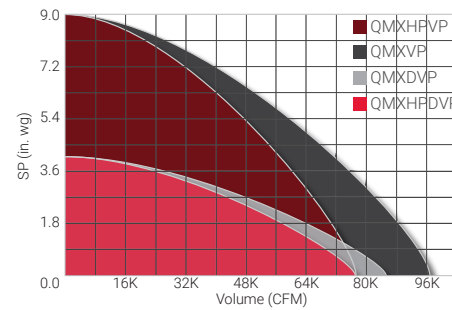

## QMXVPA

Size Range:  
120 to 600

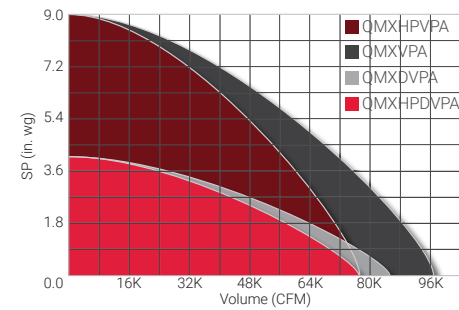

## Power Plume

Size Range:  
Low Dilution 250 to 763  
High Dilution 250 to 763

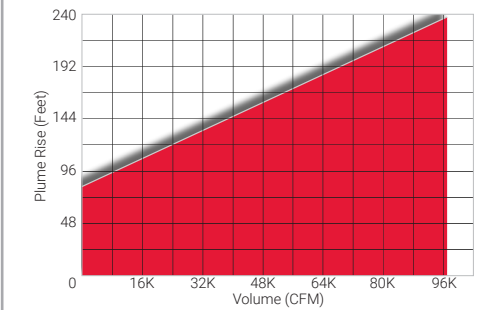

## CPSLE-S

Size Range:  
60 to 365

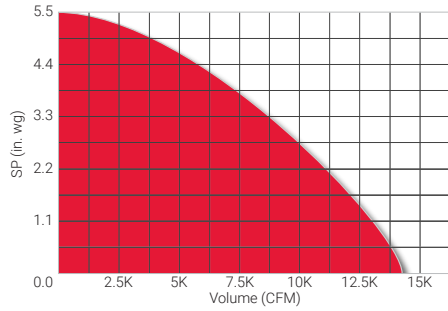

## CPSFE

Size Range:  
60 to 365

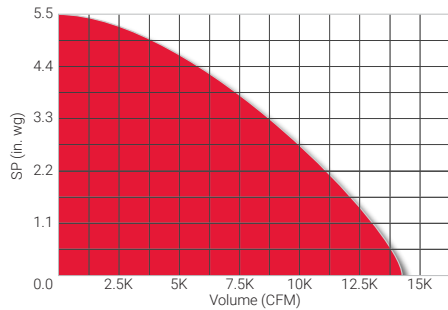

# QMX+PP

## QMX + Power Plume

Most innovative energy saving exhaust solution

The combo decouples lab exhaust from dilution and plume air, optimizing system performance as lab demand and ambient wind conditions vary

QMX + Power-Plume provides unparalleled energy efficiency in a space-efficient package



### Standard Features:

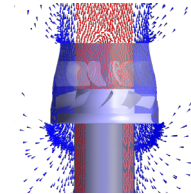

#### Power-Plume®

- Powered Induction
- Powerful Plume
- Dilution from 200-1000%
- Independent of Lab Exhaust
- No Bypass Air Needed
- Wind-Dependent Control Option

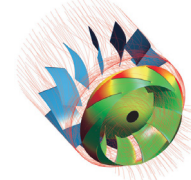

#### QMX

- Most Efficient Mixed Flow Fan
- Demand-Based Modulation to 35%
- Direct or Belt Drive
- EZ-out Option



Contact your **Cook Representative** or visit [lorencook.com](http://lorencook.com) for more information!



### PR (Intake)

Size Range:  
8 - 48"

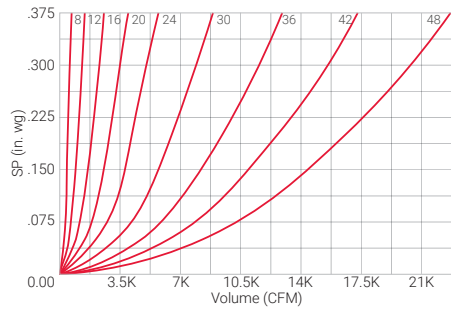
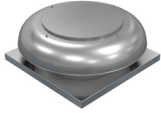

### PR (Relief)

Size Range:  
8 - 48"

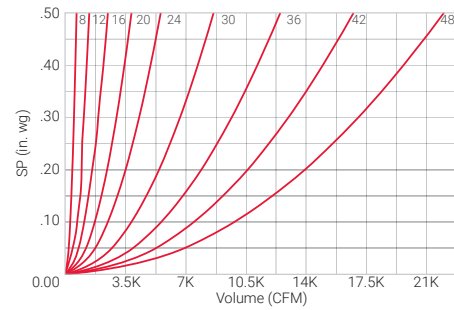
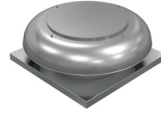

### TR

Size Range:  
8 - 48"

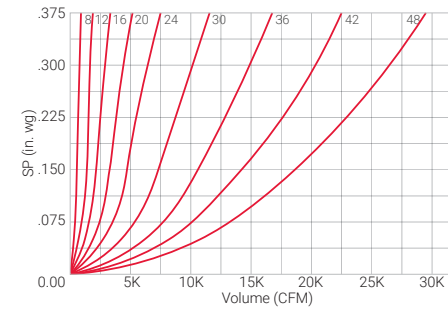
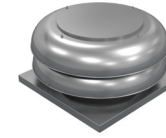

### LSUG

Size Range:  
24 to 60"

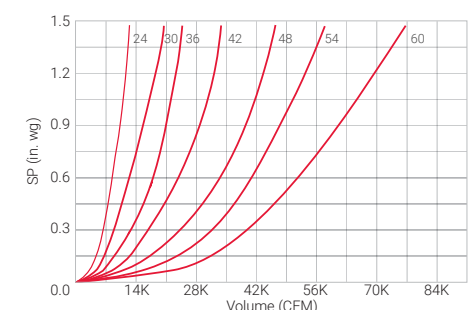

### TRE (Intake)

Size Range:  
12 x 12 to 60 x 120"

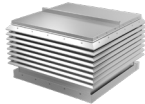

Airflow:  
Up to 63,300 CFM

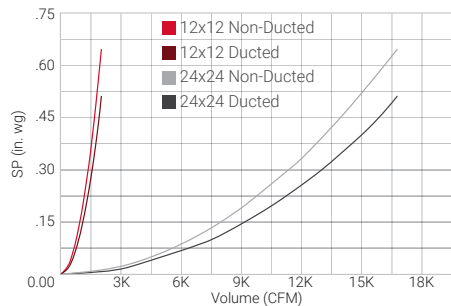

### TRE (Relief)

Size Range:  
12 x 12 to 60 x 120"

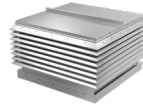

Airflow:  
Up to 56,500 CFM

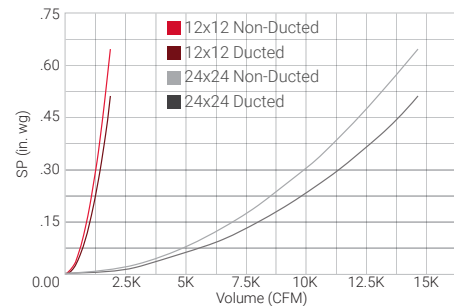

### GI

Size Range:  
12 X 12 to 72 x 144"



Airflow:  
Up to 93,600 CFM

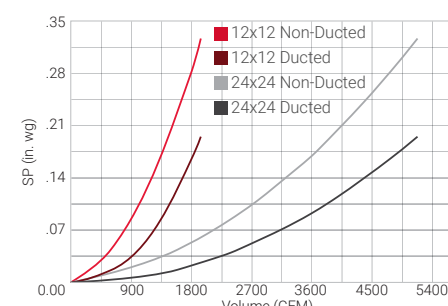

### GR

Size Range:  
12 X 12 to 72 x 144"

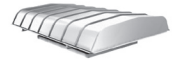

Airflow:  
Up to 86,100 CFM

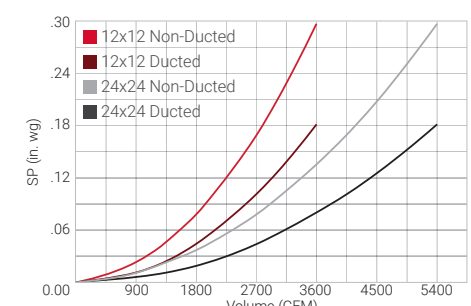

## ERVX

Size Range:  
Direct - 500 to 1250  
Belt - 1500 to 3500

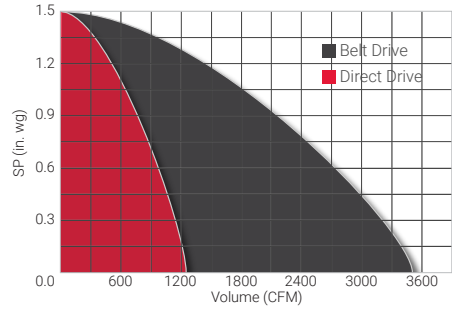

## ERV

Size Range:  
Direct - 500 to 1000  
Belt - 1500 to 10000

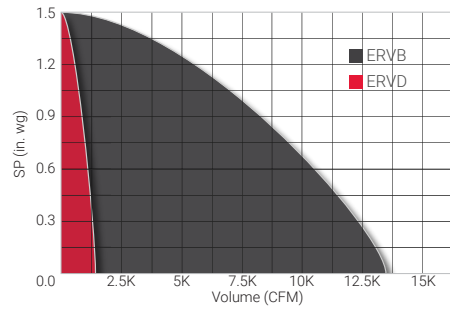

## ERC

Size Range:  
500 to 10000

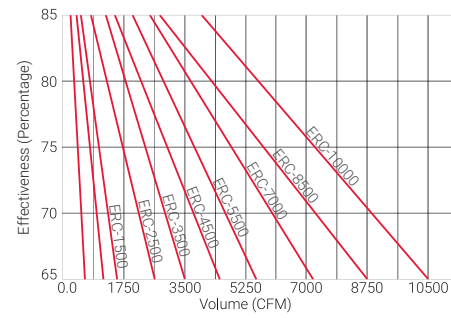
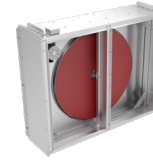

## Notes:

## HMD

Size Range:  
2400 to 4100

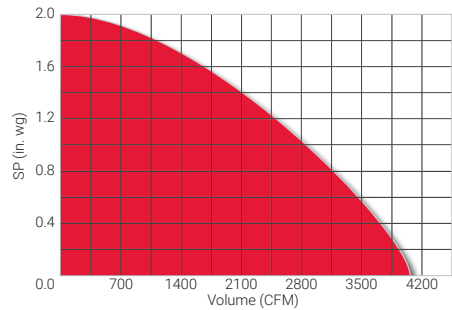

## MAC

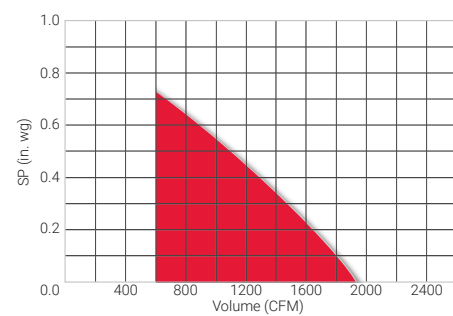

## MAC UV

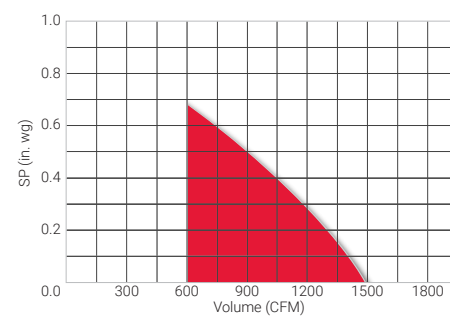



## Air Balance Kit

The Vari-Flow Air Balance Kit (VFABK) integrates and simplifies the installation while enhancing the function of Vari-Flow motors and controls.



## 2 Speed Controller

The Vari-Flow 2 Speed Controller (VF2SC) allows the setting of two separate motor speeds and switching between these speeds by an external control device.



## Pressure Controller

The Vari-Flow Pressure Controller (VFPC) addresses a wide variety of pressure-based applications. This controller is compact and easy to set up. Available in 1", 2" and 5" transducers.



## Custom Pressure Controller

The Vari-Flow Custom Pressure Controller (VFCPC) provides customizable pressure control.

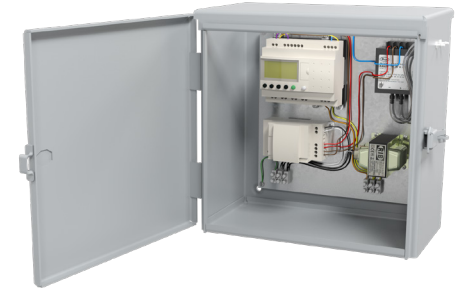

## SimpliDrive

The Vari-Flow SimpliDrive comes mounted, wired and programmed from the factory. SimpliDrive allows for easy demand-based control of the fan.



## Remote Speed Controller

The Vari-Flow Remote Speed Controller (VFRSC) allows the speed of a Vari-Flow motor to be manually adjusted and set from a location other than the fan.



## IAQ Controllers

The Vari-Flow Indoor Air Quality family of controllers is used to modulate fan speed to maintain a preset temperature, humidity, CO<sub>2</sub>, or VOC.



## Notes:



## VFD

Fan, motor, and VFD from one source. Robust, reliable, and easy to program. All VFD's can directly interface with Cook's complete line of Vari-Flow controls.



## Fan Monitor Industrial

FMI provides on-demand connection to your critical fan systems. Monitor multiple fans from anywhere with FMI's easy-to-use web-based interface. Network communication with BACnet and Modbus.



## NEED HELP WITH EC MOTORS AND CONTROLLERS?

Check out Pressure Control Basics and Cook Vari-Flow FAQ!



## Why Should I Use EC Motors and Controls? Cook Vari-Flow® FAQ



VARI-FLOW CONTROLS







2015 E. Dale St. Springfield, MO 65803 | 417-869-6474 | Fax: 417-862-3820 | [lorencook.com](http://lorencook.com)